



MERCEDES BENZ

76116081	Mercedes Benz Om 314	194
76111681	Mercedes Benz Om 364	197
76111671	Mercedes Benz Om 364	
76121721	Mercedes Benz Om 352	200
76121031	Mercedes Benz Om 352A	
76161031	Mercedes Benz Om 352A	
76113121	Mercedes Benz Om 3555	204
76112501	Mercedes Benz Om 3556	207
76121701	Mercedes Benz Om 366A	210
76141701	Mercedes Benz Om 366A	
76112791	Mercedes Benz Om 366LA	
76196125	Mercedes Benz Om 449	214
76196115	Mercedes Benz Om 447	
76114619	Mercedes Benz Om 457 Eletronico	216
76114631	Mercedes Benz Om 457	219
76114651	Mercedes Benz Om 611 Sprinter	222
76119041	Mercedes Benz Om 904	224
76119241	Mercedes Benz Om 924	
76119061	Mercedes Benz Om 906	226
76119261	Mercedes Benz Om 926	
76114682	Mercedes Benz Om 612 Acello 715	228
76112702	Mercedes Benz Om 651 Printer 311 415 515 Cdi	230

MERCEDES BENZ

MERCEDES BENZ OM 314

N°SET		DESCRIPTION	
76116081	3245800095	FULL GASKET SET MERCEDES OM 314 4 CILS C/CYLINDER 98,5 mm W/OIL	1
76126081		FULL GASKET SET MERCEDES OM 314 4 CILS / PIPE GASKET C/CYLINDER 100 mm INOX W/OIL	2
76136081		HEAD GASKET SET MBB OM 314 4 CILS C/CYLINDER 98,5 mm W/OIL SEAL	3

ABR N°	ORIGINAL N°	DESCRIPTION	
50050667		PIPE GASKET	2 2
56100298	3221310279	CYLINDER HEAD GASKET COMPRESSOR GASKET	1 1
56100590	3522030680	WATER PUMP GASKET	2 2 2
56100890	071511022006	WATER PIPE GASKET	1 1
56102690	0000910580	FUEL PUMP GASKET	1 1
56106194	3120150580	REAR COVER GASKET	1 1
56106595	3120760279	INJECTION PUMP GASKET	1 1
56106794	3211310079	AIR COMPRESSOR GASKET GASKET	1
56108701	3140160220	CYLINDER HEAD GASKET	1 1
56109090	3271840280	OIL FILTER GASKET	1 1
56109398	3522010980	WATER PUMP COVER GASKET	1 1
56109498	3522010480	WATER PUMP HOUSING GASKET	1 1
56109598	3522030080	THERMOSTATIC GASKET	2 2 2
56109698	3522030480	THERMOSTATIC GASKET	1 1 1
56109798	3522030780	THERMOSTATIC GASKET	1 1 1
56110116	071511060004	OUTLET EXHAUST GASKET	1 1 1
56110359	3520150320	FRONT COVER GASKET	1 1
56110450	3120150680	REAR COVER GASKET	1 1
56111590	3240150080	OIL COOLER COVER GASKET	1 1
56111616	3140160121	VALVE COVER GASKET	1 1 1
56111850	3140150622	SIDE VALVE COVER GASKET	1 1 1
56112398	3140160280	OIL NOZZLE JOIN GASKET	1 1 1
56112616	3141420180	EXHAUST MANIFOLD GASKET	1 1 1
56114190	3141840379	OIL FILTER GASKET	1 1
56131803	3640160320	CYLINDER HEAD GASKET	1 1
60011680		WASHER KIT	1
86101646		RUBBER KIT	1 1
86115759		OIL PAN GASKET SET	1 1
RE01810S		FRONT OIL SEAL	1 1

APPLICATION



MERCEDES OM 314 4 CIL 3.8L

MERCEDES TRUCK 608D/708D 1981/89 ; BUS LO 608 1972/76

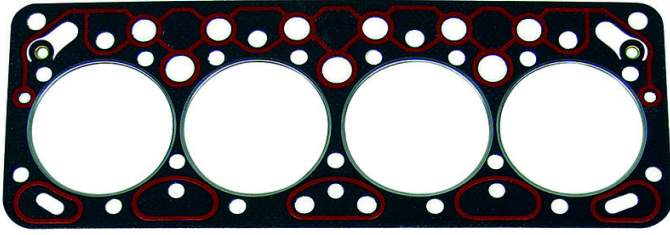

56108701 Ø 98,5 mm

56131803 Ø 100 mm

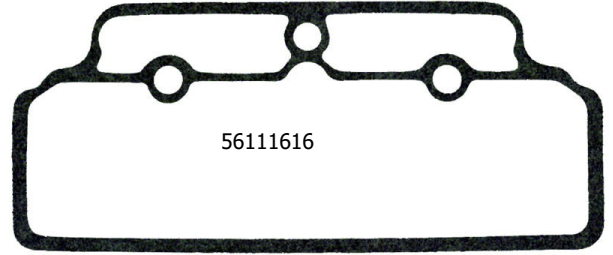

56111616



56112616



56110116

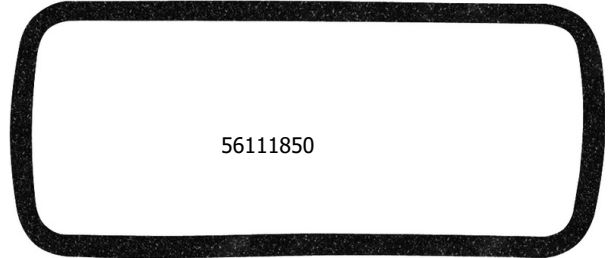

56111850



56110359

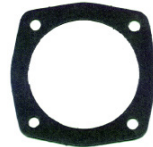

56100298

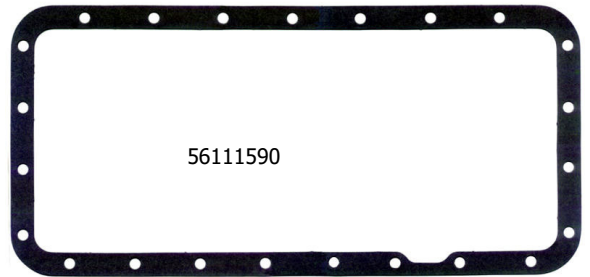

56111590

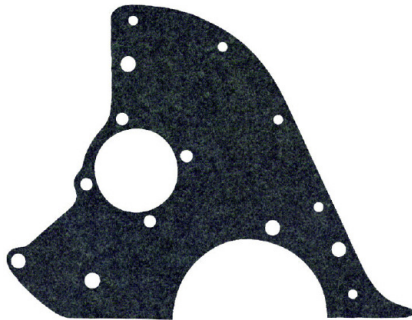

56106194



56110450



56106595



56102690

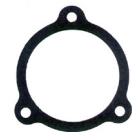

56106794



56109498



56100590



56100890



56109398



56109698



56109798



56109598

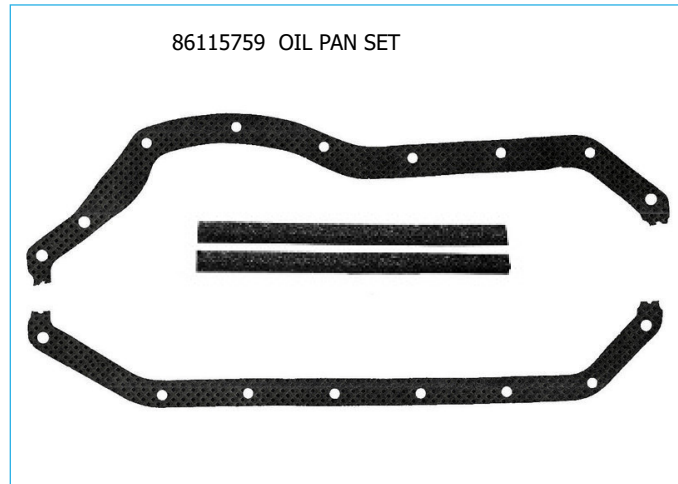

561090



56114190



56113950



50050667



56112398



RE01810S

60011680		
Nº ABR	DESCRIPTION	Qty
50012128	WASHER SET AL 8,3 x 13,8 x 1,0	05
50014123	mm	04
50021229	WASHER SET CU 9,5 x 20,0 x 1,0	02
50023329	mm	02
50030425	WASHER SET AL 14,0 x 20,0 x 1,5	02
50069329	mm	01
50029723	WASHER SET AL 16,20 x 22,0 x	04

86101646		
Nº ABR	DESCRIPTION	Qty
50005341	Vedador 8,0 X 2,7 mm	01
50035341	Vedador 31,5 x 3,8 mm	04
50035441	WASHER SET BO 14,0 x 6,0 x 8,0	05
54386740	mm	01

86101646		
Nº ABR	DESCRIPTION	Qty
50005341	Vedador 8,0 X 2,7 mm	01
50035341	Vedador 31,5 x 3,8 mm	04
50035441	WASHER SET BO 14,0 x 6,0 x 8,0	05
54386740	mm	01

N°SET	DESCRIPTION			
76111681	FULL GASKET SET MERCEDES OM 364 4 CILS C/ CYLINDER 100mm INOX W/OIL SEAL			1
76111671	FULL GASKET SET MERCEDES OM 364 4 CILS TURBINADO CYLINDER 100mm W/OIL SEAL			2
76121681	FULL GASKET SET MERCEDES OM 364 4 CILS C/ CYLINDER 98mm INOX W/OIL SEAL			3
76121671	FULL GASKET SET MERCEDES OM 364 4 CILS C/ CYLINDER 98mm INOX W/OIL SEAL			4

ABR N°	ORIGINAL N°	DESCRIPTION			
50050667		PIPE GASKET	2	2	2 2
56102690		FUEL PUMP GASKET	1	1	1 1
56100590	3522030680	WATER PUMP HOUSING GASKET	1	1	1 1
56102690	0000910580	FUEL PUMP GASKET	1	1	1 1
56106595	3120760279	INJECTION PUMP GASKET	1	1	1 1
56106794	3211310079	AIR COMPRESSOR GASKET GASKET	1	1	1 1
56109498	3522010480	WATER HOUSING GASKET	1	1	1 1
56114190	3141840379	OIL FILTER GASKET	1	1	1 1
56111590	3240150080	OIL COOLER COVER GASKET	1	1	1 1
56134894	3430150080	REAR COVER GASKET	1	1	1 1
56110450	3120150680	REAR COVER GASKET	1	1	1 1
56109090	3271840280	OIL FILTER GASKET	1	1	1 1
56100890	0715022006	WATER PIPE GASKET	1	1	1 1
56128416	3521310380	CYLINDER HEAD GASKET	1	1	1 1
56126598	3520150520	COMPRESSOR GASKET	1	1	1 1
56127695		FRONT COVER GASKET	1	1	1 1
56129490	3662030080	OIL FILTER GASKET	1	1	1 1
56131016	3640160021	THERMOSTAT GASKET	1	1	1 1
56131216	3661420180	VALVE COVER GASKET	1	1	1 1
56131316	3661410380	EXHAUST MANIFOLD GASKET	1	1	1 1
56131803	3640160320	INTAKE MANIFOLD GASKET			1 1
56131941	3640150160	CYLINDER HEAD GASKET	1	1	1 1
56133590	3460180080	SIDE COVER GASKET	1	1	1 1
56130990	3440160080	OIL FILL GAP GASKET	1	1	1 1
56148698	3641880180	INTAKE MANIFOLD GASKET TURBINA	1		1
60011680		WASHER SET	1	1	1 1
86101646		RUBBER KIT	1	1	1 1
86115759		WASHER KIT	1	1	1 1
RE01810S		REAR CRANKSHAFT GASKET	1	1	1 1

APPLICATION



MERCEDES OM 364A 4.0L TURBO
MERCEDES TRUCK 712 1995/99 ; 912 1987/95 ; 914 1994/99 ; 712 1992/03 ; 710 1992/12 ; 1214C 1997/99 ; 1114 1994/97
MERCEDES BUS LO 610 2001/03 ; LO 712 2006/10 ; LO 812 1988/10 ; LO 813 1990/96 ; LO 814 1996/04 ; OF 812 1987/97
MERCEDES OM 364 4 CIL.4.0L
MERCEDES TRUCK 709 1981/98 ; BUS LO 809 1991/94

MERCEDES BENZ
MERCEDES BENZ OM 364

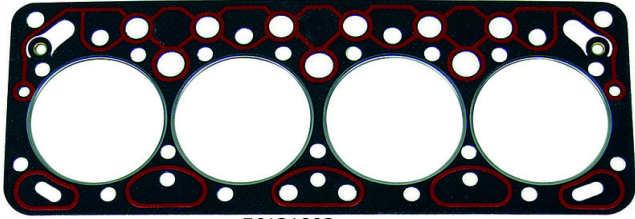

56131803

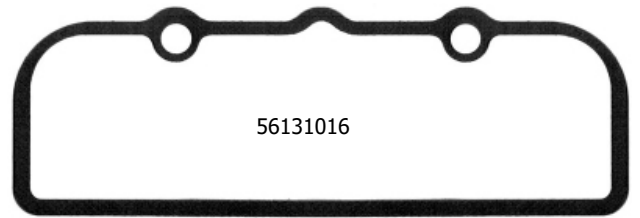

56131016

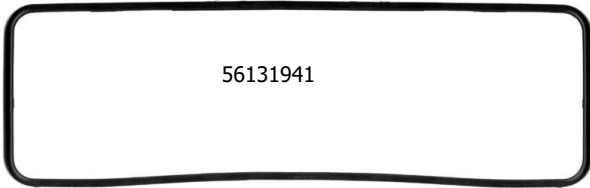

56131941



56111590



56131216



56131316

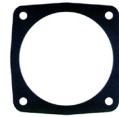

56128416



56109090



56130990



56134894



56100890



56126598



56110450



56106794

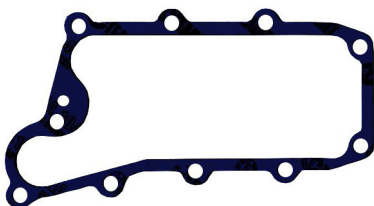

56148698



56102690



56106595



56109498



56133590



56129490



56100590



56127695



50050667



RE01810S



56114190



54310990

60011680		
Nº ABR	DESCRIPTION	Qty
50012128	WASHER SET AL 8,3 x 13,8 x 1,0	05
50014123	mm	04
50021229	WASHER SET CU 9,5 x 20,0 x 1,0	02
50023329	mm	02
50030425	WASHER SET AL 14,0 x 20,0 x 1,5	02
50069329	mm	01
50029723	WASHER SET AL 16,20 x 22,0 x	04

86101646		
Nº ABR	DESCRIPTION	Qty
50005341	Vedador 8,0 X 2,7 mm	01
50035341	Vedador 31,5 x 3,8 mm	04
50035441	WASHER SET BO 14,0 x 6,0 x 8,0	05
54386740	mm	01

MERCEDES BENZ

MERCEDES BENZ OM 352 / 352 A

N°SET	DESCRIPTION					
76141721	FULL GASKET SET MERCEDES OM 352 70/76 C/CYLINDER98,5mm W/OIL SEAL					1
76121721	0445800095	FULL GASKET SET MERCEDES OM 352 6 CILS / PIPE GASKET / CYLINDER 100mm INOX				2
76141031	775800195	FULL GASKET SET MERCEDES OM 352A 6 CILS C/CYLINDER 98,5mm INOX, W/OIL				3
76121031		FULL GASKET SET MERCEDES OM 352A 6 CILS / CYLINDER 100mm INOX W/OIL SEAL				4
76131031		FULL HEAD GASKET SET MERCEDES OM 352/352 A W/OIL SEAL				5
76161031		FULL GASKET SET MERCEDES OM 352A/CYLINDER 100mm INOX e LAT BORRACHA W/OIL SEAL				6
ABR N°	ORIGINAL N°	DESCRIP-				
50050667	0009979641	PIPE GASKET	2	2	2	2
54310990	632148530124	FUEL PUMP GASKET	1	1	1	1
56100298	3221310279	CYLINDER HEAD GASKET	1	1	1	1
56100590	3522030680	COMPRESSOR GASKET	2	2	2	2
56100616	3221420580	WATER PUMP GASKET				2
56100631	3521450080	EXHAUST MANIFOLD GASKET	2	2	2	2
56100890	07151102206	EXHAUST MANIFOLD GASKET	1	1	1	1
56101216	3024900080	WATER PIPE GASKET	1	1	1	1
56102690	0000910580	OUTLET EXHAUST GASKET	1	1	1	1
56106056	3520150122	FUEL PUMP GASKET		1	1	1
56106170	3121881579	SIDE VALVE GASKET	1	1	1	1
56106450	3120180280	OIL COOLER GASKET	1	1	1	1
56106595	3120760279	OIL PUMP COVER GASKET	1	1	1	1
56106794	3211310079	INJECTION PUMP GASKET	1	1	1	1
56107716	3124921080	AIR COMPRESSOR GASKET GASKET				1
56109090	3271840280	OUTLET EXHAUST GASKET	1	1	1	1
56109398	3522010980	OIL FILTER GASKET	1	1	1	1
56109498	3522011480	WATER PUMP COVER GASKET	1	1	1	1
56109598	3522030080	WATER PUMP HOUSING GASKET	2	2	2	2
56109698	3522030480	THERMOSTAT GASKET GRD	1	1	1	1
56109798	3522030780	THERMOSTAT GASKET PEQ	1	1	1	1
56110216	3520160421	THERMOSTAT GASKET MED	1	1	1	1
56110359	3520150320	VALVE COVER GASKET		1	1	1
56110450	3120150680	FRONT COVER GASKET	1	1	1	1
56112298	3522011280	REAR COVER GASKET	1	1	1	1
56114190	3141840379	WATER PUMP GASKET	1	1	1	1
56121131	3520980880	OIL FILTER GASKET	1	1	1	
56121231	3520980280	TURBOCHARING GASKET	1	1	1	
56121396		TURBOCHARING GASKET	1	1	1	
56126598	3520150520	OIL PAN GASKET	1			
56128416	3521310380	FRONT COVER GASKET	1	1	1	1
56131141	3520150160	CYLINDER HEAD GASKET	1			
56149098	3520180380	COMPRESSOR GASKET	1	1	1	1
56149603	3520160120	SIDE COVER GASKET VÁLVULA			1	1
56150201	3520161520	CYLINDER HEAD GASKET	1	1	1	1
60011720		CYLINDER HEAD GASKET	1	1	1	1
86111175	0445860018	CYLINDER HEAD GASKET	1	1	1	1
86112159		WASHER KIT	1	1	1	1
86148840		OIL COOLER GASKET	1	1	1	1
86149740		OIL PAN SET	1	1	1	1
RE01810S		RUBBER KIT	1	1	1	1

APPLICATION



MERCEDES OM 352A 6 CIL 5.7L TURBO
MERCEDES TRUCK 2014 1975/89 1514 1979/89 1117 1981/90 ; 1316/1317/1516 1981/89 1517 1986/87 1518/2018 1981/91; 2216/2217 1981/87
MERCEDES BUS O 365 1986/89 OF 1316 1982/86
MERCEDES OM 352 6 CIL 5.7L
MERCEDES TRUCK 1114 1981/90 1113 1970/87 1313/1513/2013 1970/89 2213 1971/89;
MERCEDES BUS O 364 1978/84 OF 1113 1980/81 OF 1313/OH 1313 1970/86 OF 1314 1987/87

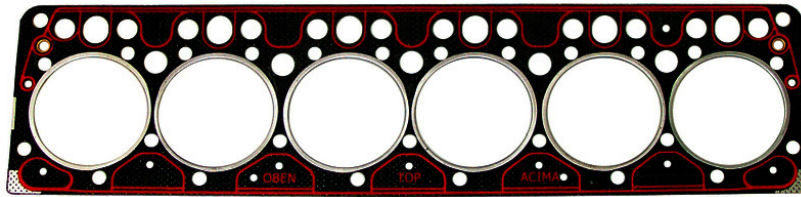

56149603 Ø 98,5 mm

56150201 Ø 100 mm

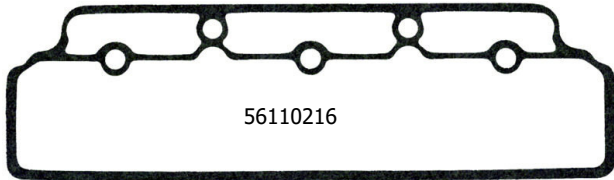

56110216

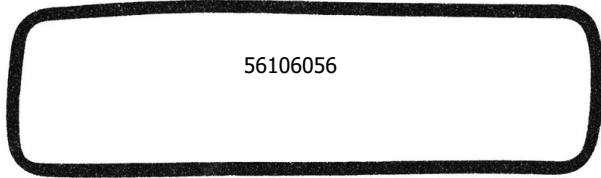

56106056

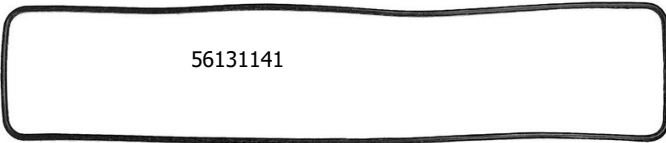

56131141

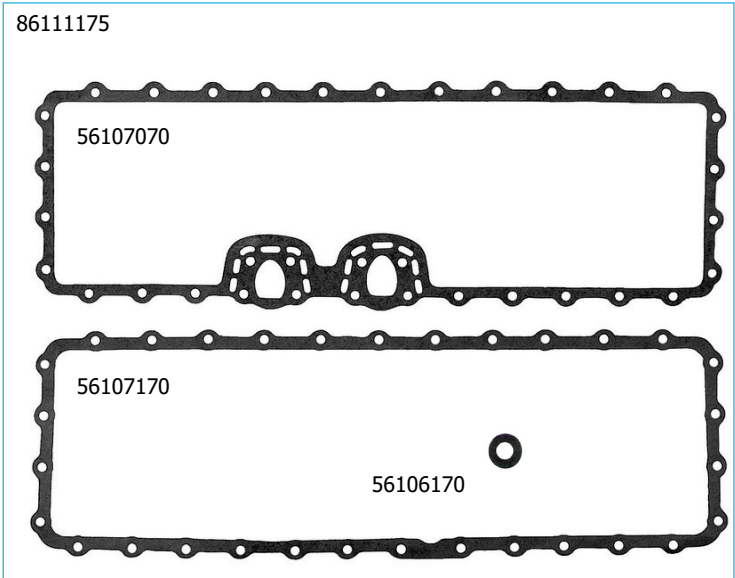

86111175

56107070

56107170

56106170



56100631



56100616



56121231



54310990



56101216



56107716



56121131



56121496



56110359



56126598

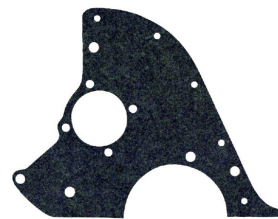

56106170



56100298



56109090



56121396



56149098



56128416



56114190



56110450



56113950



56106794

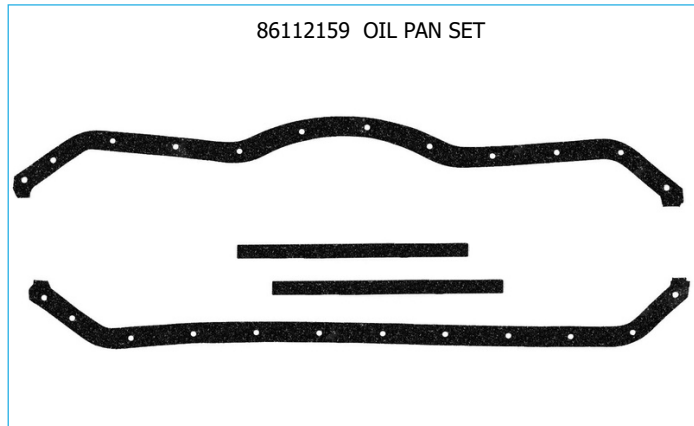

86112159 OIL PAN SET



56106595



56102690

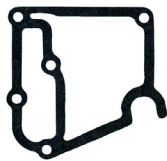

56112298



56109498



56109698

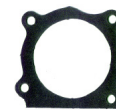

56109798

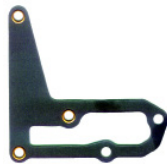

56109398



56100890



56100590



56109598



50050667



RE01810S

86149740

Nº ABR	DESCRIPTION	Qty
50014123	WASHER SET do Bico Injetor	06
56129723	WASHER SET Dupla do Bico Injetor	06
50035441	vedador do Injetor	07
50035341	Anel Vedador da antecâmara	06

60011720

Nº ABR	DESCRIPTION	Qty
	WASHER SET AL 26,2 x 32,0 x 1,5	01
50011238	mm	16
50011428	WASHER SET AC 8,0 x 12,0 x 1,0	06
50013860	mm	04
50014123	WASHER SET AL 8,1 x 13,8 x 1,0	06
50015428	mm	06
50021129	WASHER SET FB 9,0 x 18,0 x 0,4	01
50021229	mm	18
50023329	WASHER SET CU 9,5 x 20,0 x 1,0	06
50025424	mm	02
	WASHER SET AL 10,2 x 14,0 x 1,0	01
50030425	mm	01
50069229	WASHER SET AL 14,0 x 18,0 x 1,5	03
50072429	mm	01
56129723	WASHER SET AL 14,0 x 20,0 x 1,5	06

86148840

DESCRIPTION	Qty
Anel BO 30,8 x 3,7 mm	05
Anel BO 62,0 x 3,0 mm	01
Anel BO 28,3 x 2,0 mm	01
Anel BO 8,3 x 2,5 mm	01
Anel BO 13,1 x 2,6 mm	01
Anel BO 115,0 x 5,0 mm	01
Anel BO 95,5 x 105,0 x 3,0 mm	01
Anel BO 6,0 x 14,0 x 8,0 mm	07
Anel BO 14,2 x 23,7 x 6,3 mm	01
Anel BO 13,8 x 27,9 x 10,5 mm	01

MERCEDES BENZ

MERCEDES BENZ OM 355/5

N°SET	DESCRIPTION		
66113121	FULL GASKET SET MERCEDES OM 355/5 Cil's COM CYLINDER W/O OIL SEALTOR		1
76113121 3655860290	FULL GASKET SET MERCEDES OM 355/5 Cil's COM CYLINDER E W/OIL SEAL		2
ABR N°	ORIGINAL N°	DESCRIPTION	
RE00269S	0149974647	FRONT OIL SEAL	1
RE01815F	4220530196	AFTER COOLER GASKET	20
56101139		EXHAUST MANIFOLD GASKET	5 5
56101317	3451420080	OUTLET EXHAUST GASKET	1 1
56101490	3444920080	OIL BODY FILTER GASKET	1 1
56101790	3151840180	WATER PUMP GASKET	1 1
56102270	3152010180	OIL PUMP HOUSING GASKET	5 5
56111716	0651810079	VALVE COVER GASKET	1 1
56111903	3460160221	CYLINDER HEAD GASKET	1 1
56112298	3550160220	WATER PUMP GASKET	1 1
56113950	3522011280	OIL NOZZLE JOIN GASKET	1 1
56116359	3120180180	FRONT COVER GASKET	1 1
56116416	3460150120	INTAKE MANIFOLD GASKET	1 1
56117890	3461410180	WATER PUMP HOUSING GASKET	1 1
56117990	3562010180	SIDE VALVE COVER GASKET	1 1
56118090	3550150022	OIL FILTER GASKET	1 1
56118190	3551840480	OIL COOLER GASKET	1 1
56118416	3551880080	CYLINDER HEAD GASKET	1 1
56118690	0001314380	COMPRESSOR GASKET	1 1
56118790	3460070380	TOP INJECTION PUMPGASKET	5 5
56118890	3552030080	THERMOSTATIC GASKET	1 1
56118990	3269970149	WATER PIPE GASKET	1 1
56119090	07151040017	BREATHER PIPE TUBE GASKET	1 1
56119190	3270750180	INJECTION PUMP HOUSING GASKET	1 1
56119290	3030180079	OIL ROD GASKET	1 1
56119803	000911280	FUEL PUMP GASKET	1 1
56120016	3460160020	CYLINDER HEAD GASKET	2 2
56120190	3451410080	INTAKE MANIFOLD GASKET	1 1
56120290	071511026003	OIL PUMP COVER GASKET	1 1
56133590	3552010080	WATER PIPE GASKET	1 1
60013120	3460180080	OIL FILL GAP GASKET	1 1
86100846		WASHER KIT	1 1
86117690		RUBBER KIT	1

APPLICATION



MERCEDES TRUCK 1519 1973/89 1520 1981/90 2220 1987/91 2219 1977/89 1525 1985/90 2225 1989/89

MERCEDES BUS O 364 1978/86 O 370R 1984/87 O 371 R 1987/90 O 371 UP 1987/93 OH 1419/OH 1517 1976/86 OH 1519 1973/86 OH 1520 1988/92 OH 1518 1979/86



56111903



56119803

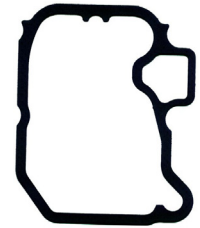

56111716

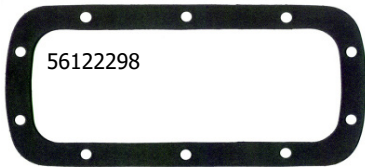

56122298

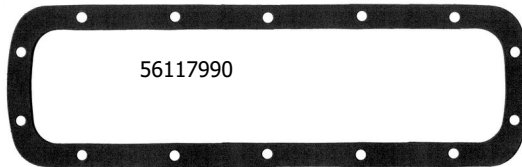

56117990



56120016



56119690



56116416



56101317



56101139



56113950

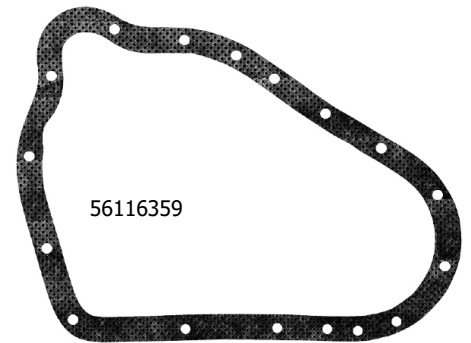

56116359

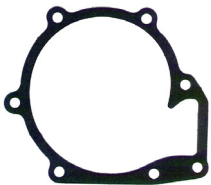

56117890

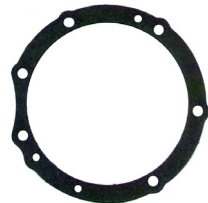

56118690



56118416



56101590



56118890



56120290



56119090

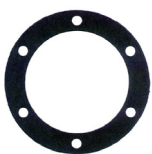

56101790



56119290



56118990



56118790

86117690	
	
56122490 ORIG 0001312079	56122690 ORIG 0001312179
56122590 ORIG 3520140922	
	

MERCEDES BENZ

MERCEDES BENZ OM 355/5

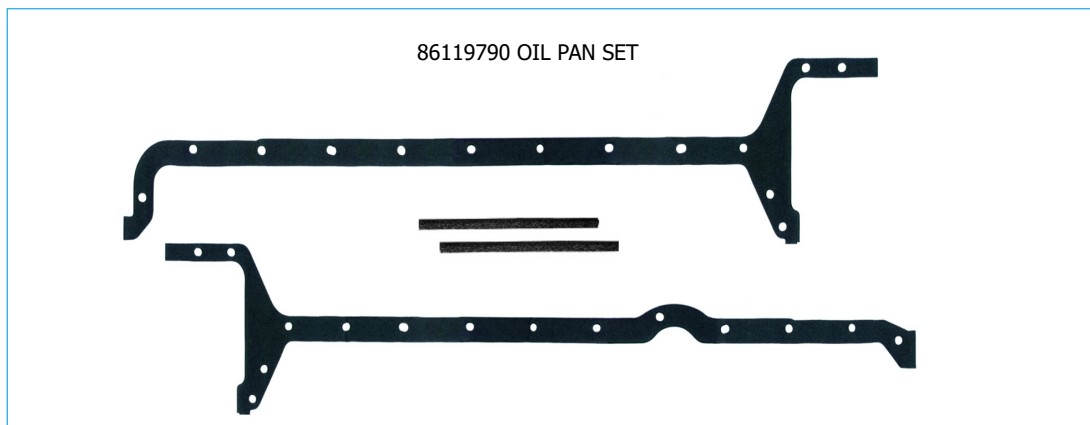

60013120		
Nº ABR	DESCRIPTION	Qty
50011428	WASHER SET AL 8,3 x 13,8 x 1,0	15
50014123	mm	05
50021229	WASHER SET CU 9,5 x 20,0 x 1,0	12
50032729	mm	02
50029525	WASHER SET AL 14,0 x 20,0 x 1,5	02
50069229	mm	02
50012928	WASHER SET AL 30,0 x 36,0 x 1,5	12
50034920	mm	07
50021129	WASHER SET AL 24,0 x 29,4 x 2,0	01
50023329	mm	02
50027329	WASHER SET AL 18,0 x 22,0 x 1,5	01
50072429	mm	06
50029723	WASHER SET AL 8,3 x 11,4 x 1,0	05

86100846		
Nº ABR	DESCRIPTION	Qty
50007841	Vedador 27,0 x 3,3 mm	02
50028441	Vedador 117,0 x 4,8 mm	01
50035341	Vedador 30,8 x 3,7 mm	05
54386740	Vedador 12,5 x 2,6 mm	01
50040041	Vedador 18,0 x 2,5 mm	01
50002841	Tubo Arrefecimento	05
50003041	Coletor Admissão	01

N°SET	DESCRIPTION	
661125013455860390	FULL GASKET SET MERCEDES OM 355/6 Cil's C/CYLINDER W/O OIL SEAL	
761125013455860390	FULL GASKET SET MERCEDES OM 355/6 Cil's C/CYLINDER W/OIL SEAL	
ABR N°	ORIGINAL N°	DESCRIPTION
RE00269S	0049973947	DISTRIBUTION SEAL
RE01815F		VALVE STEM SEAL
56101139	3451420080	EXHAUST MANIFOLD GASKET
56101317	3444920080	OUTLET EXHAUST GASKET
56101490	3151840180	OIL BODY FILTER GASKETRO
56101790	3152010180	WATER PUMP GASKET
56102270	0651810079	OIL PUMP HOUSING GASKET
56111716	3460160221	VALVE COVER GASKET
56111903	355016220	CYLINDER HEAD GASKET
56113950	3120180180	OIL FILL GAP GASKET
56116359	3460150120	FRONT COVER GASKET
56116416	3461410180	INTAKE MANIFOLD GASKET
56117790	3560150021	VALVE COVER GASKET
56117890	3562010180	WATER PUMP HOUSING GASKET
56117990	3550150022	SIDE COVER GASKET
56118090	3551840480	OIL FILTER GASKET
56118190	3551880080	OIL COOLER HOUSING GASKET
56118416	0001314380	CYLINDER HEAD GASKET
56118690	3460070380	COMPRESSOR GASKET
56118790	3552030080	INJECTOR PUMP GASKET
56118890	3269970149	THERMOSTATIC GASKET
56118990	07151040017	WATER PIPE GASKET
56119090	3270750180	BREATHER PIPE GASKET
56119190	3030180079	INJECTOR PUMP GASKET
56119290	0000911280	OIL ROD GASKET
56120190	071511026	FUEL PUMP GASKET
56120290	3552010080	OIL PUMP COVER GASKET
56133590	3460180080	WATER PIPE GASKET
60012500		OIL FILL GAP GASKET
86100946		WASHER KIT
86116190	3555860001	RUBBER KIT
86117690		OIL PAN GASKET
RE01860N	0039974046	COMPRESSOR GASKET

APPLICATION



MERCEDES TRUCK 1524 1985/89 1924 1974/87 2624 1974/...1525 1985/90 2225 1989/89 1929 1984/87 1932/1933 1984/89 1934 1987/89

MERCEDES BUS O 355 1972/75 O 370 RS/O 370 RSD 1976/90 OH 1420 1972/86

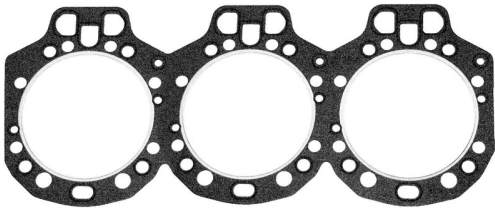

56111903

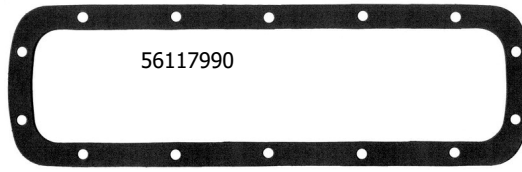

56117990



56111716

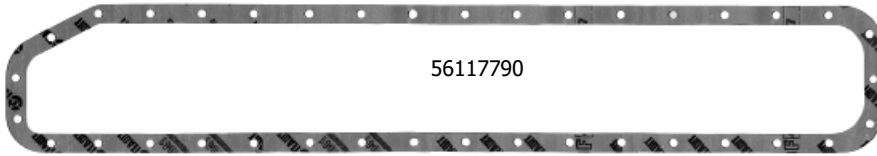

56117790



50013249



56101139



56101317



56116416

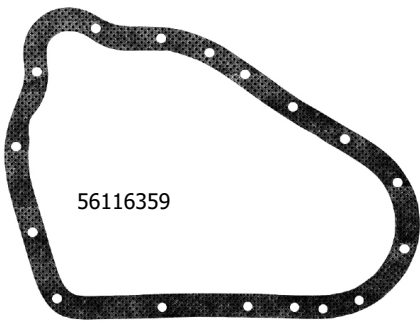

56116359

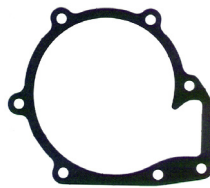

56117890

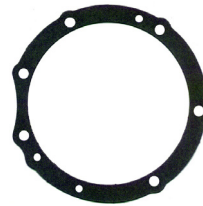

56118690



56118416



56118890



56101590



56120290



56119090

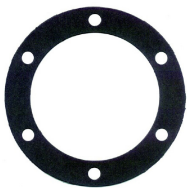

56101790



56119290



56118990



56118790



86116190 OIL PAN SET



56119190



56113950

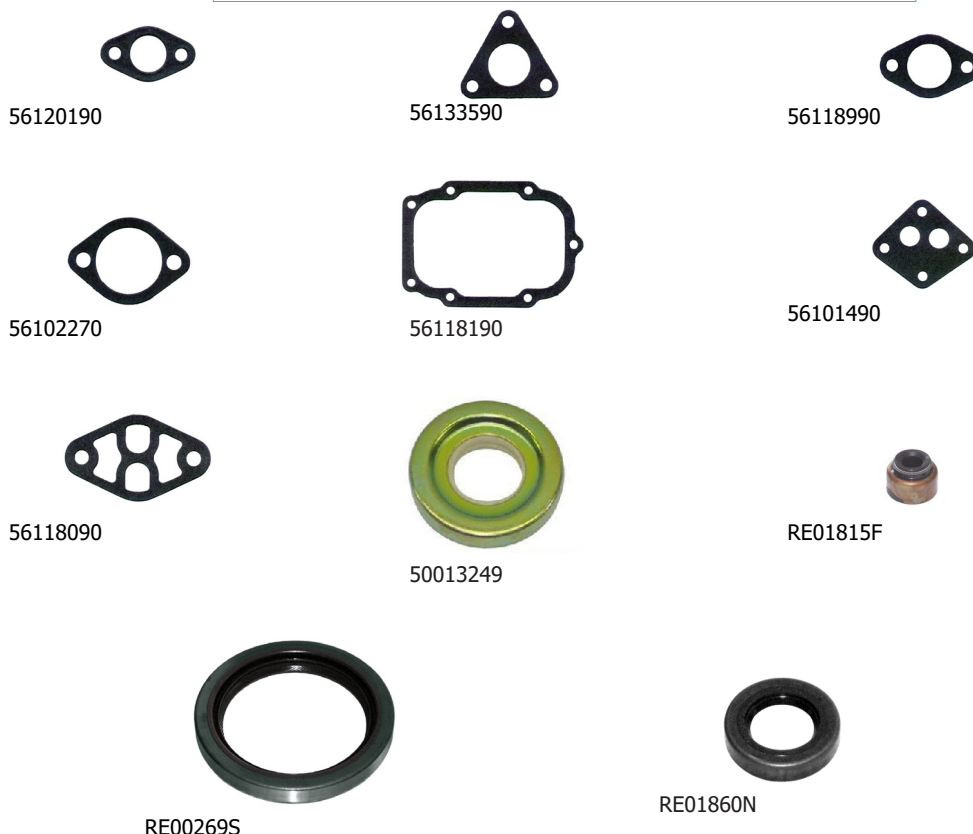

60012500		
Nº ABR	DESCRIPTION	Qty
50011428	WASHER SET AL 8,3 x 13,8 x 1,0	18
50014123	mm	06
50021229	WASHER SET CU 9,5 x 20,0 x 1,0	14
50092728	mm	06
50032729	WASHER SET AL 14,0 x 20,0 x 1,5	02
50029525	mm	02
50069229	WASHER SET AL 12,0 x 16,0 x 1,0	02
50012928	mm	14
50034920	WASHER SET AL 30,0 x 36,0 x 1,5	07
50021129	mm	02
50023329	WASHER SET AL 24,0 x 29,4 x 2,0	02
50027329	mm	02
50072429	WASHER SET AL 18,0 x 22,0 x 1,5	06
50029723	mm	06

86100946		
Nº ABR	DESCRIPTION	Qty
50007841	Vedador 27,0 x 3,3 mm	01
50028441	Vedador 117,0 x 4,8 mm	01
50035341	Vedador 30,8 x 3,7 mm	06
54386740	Vedador 12,5 x 2,6 mm	01
50007941	Vedador 23,0 x 3,5 mm	02
50002841	Tubo Arrefecimento	06
50003041	Coletor Admissão	01

N°SET	DESCRIPTION					
76121701	FULL GASKET SET MERCEDES OM 366A C/CYLINDER 98,5mm W/OIL SEAL					1
76121691	FULL GASKET SET MERCEDES OM 366 C/CYLINDER 98,5mm W/OIL SEAL					2
76141701	FULL GASKET SET MERCEDES OM 366A C/CYLINDER 100mm W/OIL SEAL					3
76131691	HEAD GASKET SET MERCEDES OM 366/366A C/CYLINDER 100mm W/OIL SEAL					4
76112791	FULL GASKET SET MERCEDES OM 366 LA C/CYLINDER W/OIL SEAL					5
76111691	FULL GASKET SET MERCEDES OM 366 C/CYLINDER 100mm W/OIL SEAL					6
ABR N°	ORIGINAL N°	DESCRIPTION				
50050667		PIPE GASKET	2	2	2	2
56102690		OIL COVER PIPE GASKET		1	1	1
56100298	3221310279	CYLINDER HEAD GASKET	1	1	1	1
56100590	3522030680	WATER PUMP GASKET	2	2	2	2
56102690	0000910580	FUEL PUMP GASKET	1	1	1	1
56113950		OIL NOZZLE JOIN GASKET	1	1	1	1
56106595	3120760279	INJECTION PUMP GASKET	1	1	1	1
56106794	3211310079	AIR COMPRESSOR GASKET	1	1	1	1
56109498	3522010480	GASKET	1	1	1	1
56110450	3120150680	WATER PUMP HOUSING	1		1	1
56114190	3141840379	GASKET	1	1	1	1
56121131	3520980880	REAR COVER GASKET		1	1	
56121231	3520980280	OIL FILTER GASKET	1		1	1
56121496		TURBOCHARING GASKET		1	1	1
56126598	3520150320	TURBOCHARING GASKET	1	1	1	1
56128416	3521310380	INLET OIL GASKET TURBINA	1	1	1	1
56129490	3662030080	FRONT COVER GASKET	1	1	1	1
56129532	3622010080	CYLINDER HEAD GASKET	1	1	1	1
56130516	3660160021	COMPRESSOR GASKET	1	1	1	1
56130616	6004920080	THERMOSTAT GASKET	1	1	1	1
56130990	3440160080	WATER PUMP GASKET	1	1	1	1
56131141	3520150160	VALVE COVER GASKET	1	1	1	1
56131231	3661420180	OUTLET EXHAUST GASKET	4	4	4	4
56131316	3661410380	INTAKE MANIFOLD GASKET	3	3	3	3
56133590	3460180080	TURBOCHARGING	1	1	1	1
56134894	3430150080	SIDE VALVE COVER GASKET	1	1	1	1
56139316	3521310280	EXHAUST MANIFOLD GASKET	1	1	1	1
56143990	3520180980	INTAKE MANIFOLD GASKET	2	2	2	2
56148390	9170030200	OIL FILL GAP GASKET	2	2	2	2
56149198		REAR COVER GASKET	2	2	2	2
56149603	3520160120	CYLINDER HEAD GASKET				1
56150201	3520161520	COMPRESSOR GASKET	1	1	1	1
56151280		OIL ROD GASKET		1		
56170167		OIL COOLER GASKET		1		
60011720		AFTERCOOLER SET	1	1	1	1
86112159		CYLINDER HEAD GASKET	1	1	1	1
86126670	0445860018	CYLINDER HEAD GASKET	1	1	1	1
86148940		FRONT COVER GASKET	1	1	1	1
86149740		FRONT COVER GASKET		1	1	1
RE01810S		WASHER KIT	1	1	1	1

APPLICATION



MERCEDES OM 366 6 CIL 6.0L
MERCEDES TRUCK 2217 1987/90 ; 1314/2216 1987/89 ; 1214 1989/96 ; 1714 1991/96 ; 1414/1614 1989/96 ; 2214 1987/89 2314 1990/94
MERCEDES BUS OF 1315 1988/94 ; O 371 ST 1988/94 ; OH 1315 1988/95 ; OF 1115 1988/92
MERCEDES OM 366LA 6 CIL 6.0L TURBO
MERCEDES TRUCK 1721 1991/98 ; 1621 1987/97 ; 1420 2002/05 ; 1720 1997/06 ; 1723 1997/01 ; 1620 1993/05
MERCEDES OM 366A 6 CIL 6.0L TURBO
MERCEDES TRUCK 1218 1989/00 ; 1318 1989/03 ; 1118 1987/90 ; 2318/2418 1990/99 ; 1718 1991/99 ; 1618 1981/96 ; 1418 1989/00
MERCEDES BUS O 371 U 1987/94 ; OF 1618 1992/94 ; OH 1318 1988/97 ; OF 1318 1988/07 ; OF 1620 1995/99 ; OF 1721 1998/05
OH 1420 1998/03 ; OH 1420 1998/03 ; O 371 UL 1994/97 ; OH 1421/OH 1521/OH 1623 LG 1998/04 ; OH 1621/L/LE 1997/05

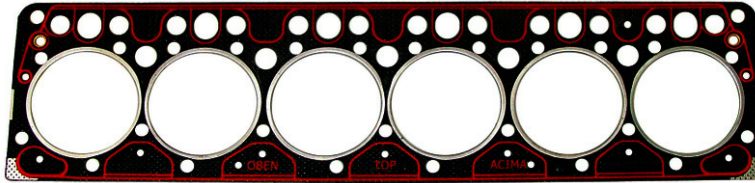

56149603 Ø 98,5 mm

56150201 Ø 100 mm

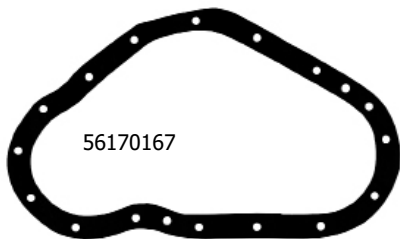
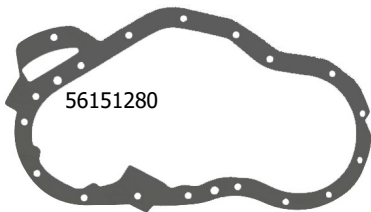
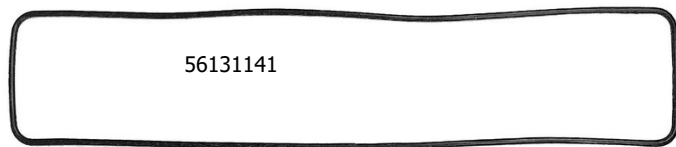
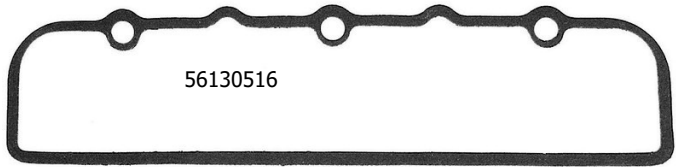

56148390



56121396



56134894



56114190



56127695



56149198



56110450



56130616



56143990



56128416



56113950



56131231



56130990



56139316



56106794



56121231



56121131



54310990



56121496

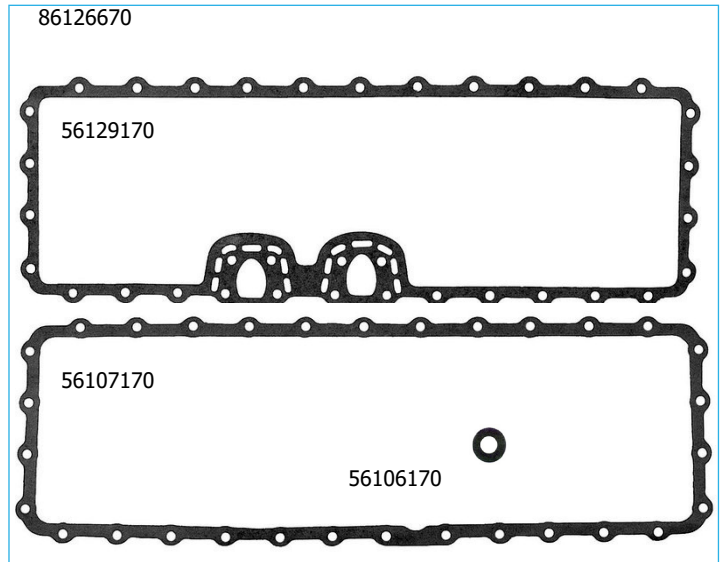

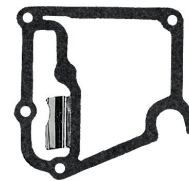
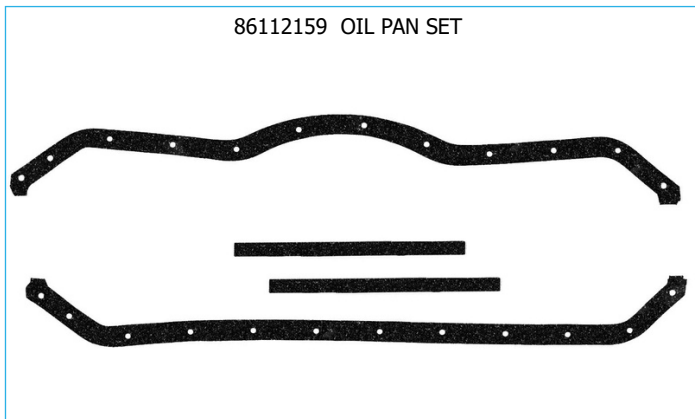

56129532



56102690



56126598



56129490



56109498



56106595



56113950



56133590



56100590



50050667



RE01810S

86148940	
DESCRIPTION	Qty
Anel BO 30,8 x 3,7 mm	06
Anel BO 34,0 x 4,0 mm	02
Anel BO 8,3 x 2,5 mm	04
Anel BO 60 x 4,2 mm	01
Anel BO 45,0 x 4,0 mm	02
Anel BO 13,1 x 2,6 mm	01
Anel BO 28,5 x 2,5 mm	01
Anel BO 62,0 x 3,0 mm	01
Anel BO 75,0 x 3,0 mm	01
Anel BO 101,0 x 4,3 mm	02
Anel BO 14,0 x 7,5 mm	07
Anel BO 14,0 x 23,7 x 6,3 mm	01

86149740		
Nº ABR	DESCRIPTION	Qty
50014123	WASHER SET do Bico Injetor	06
56129723	WASHER SET Dupla do Bico Injetor	06
50035441	vedador do Injetor	07
50035341	Anel Vedador da antecâmara	06

60011720		
Nº ABR	DESCRIPTION	Qty
	WASHER SET AL 26,2 x 32,0 x 1,5	01
50011238	mm	16
50011428	WASHER SET AC 8,0 x 12,0 x 1,0	06
50013860	mm	04
50014123	WASHER SET AL 8,1 x 13,8 x 1,0	06
50015428	mm	06
50021129	WASHER SET FB 9,0 x 18,0 x 0,4	01
50021229	mm	18
50023329	WASHER SET CU 9,5 x 20,0 x 1,0	06
50025424	mm	02
	WASHER SET AL 10,2 x 14,0 x 1,0	01
50030425	mm	01
50069229	WASHER SET AL 14,0 x 18,0 x 1,5	03
50072429	mm	01
56129723	WASHER SET AL 14,0 x 20,0 x 1,5	06

MERCEDES BENZ

MERCEDES BENZ OM 447 / 449

N°SET	DESCRIPTION				
66196125	FULL GASKET SET MERCEDES OM 449 5 CILS COM ANEL CAMISA, W/O O ILSEAL				1
76196125	FULL GASKET SET MERCEDES OM 449 5 CILS COM ANEL CAMISA, W/OIL SEAL				2
66136125	HEAD GASKET SET P/ 1 CYLINDER OM 447 / 449 W/O OIL SEAL				3
76136125	HEAD GASKET SET P/1 CYLINDER OM 447/449 VALVE STEM SEAL W/OIL SEAL				4
66196115	FULL GASKET SET MERCEDES OM 447 6 CILS COM ANEL CAMISA, W/O OILSEAL				5
76196115	FULL GASKET SET MERCEDES OM 447 6 CILS COM ANEL CAMISA, W/OIL SEAL				6

ABR N°	ORIGINAL N°	DESCRIPTION			
RE02696T	0149974647	FRONT OIL SEAL	1		1
RE02697T	0139971447	REAR OIL SEAL	1		1
RE02786F	4220530196	VALVE STEM SEAL	12	2	10
50014123		WASHER SET		1	1
54308395	6171870180	INLET OIL GASKET	1	1	1
54308490	4421870080	OUTLET OIL GASKET	1	1	1
56128690	4030180180	OIL PAN GASKET	1	1	1
56129890	4750980380	INTAKE MANIFOLD GASKET	1	1	1
56130290	4750880280	INTAKE MANIFOLD GASKET	1	1	1
56130390	4222010480	WATER PUMP GASKET	1	1	1
56130490	4030160321	VALVE COVER GASKET	6	6	1
56130616	6004920080	OUTLET EXHAUST GASKET	1	1	1
56132298	4030110080	FRONT COVER GASKET	1	1	1
56132490	4031840280	OIL FILTER GASKET	1	1	1
56132590	4032011080	WATER PUMP GASKET	1	1	1
56132690	91700304003	CONNECTION GASKET	1	1	1
56132795	91700303002	OIL PUMP GASKET	1	1	1
56132950	4750150180	OUTLET OIL GASKET	1	1	1
56137200	4220160420	CYLINDER HEAD GASKET	6	6	1
56139239	4031420380	EXHAUST MANIFOLD GASKET	6	6	1
56141317	4421411180	INTAKE MANIFOLD GASKET	6	6	1
56142398	4290150080	FRONT COVER GASKET	1	1	1
56142490	917003026000	OIL COOLER GASKET	2	2	2
56151067	4220160420	OIL PAN GASKET			1
56151167	4070140222	OIL PAN GASKET	1	1	
56164640	0039975750	INJECTOR PLUG GASKET	6	6	1
60086110		WASHER KITUELA	1	1	1
86149032		KIT ANÉIS CAMISA	6	6	5

APPLICATION



MERCEDES OM 449A/449LA 5 CIL 8V 10L TURBO

MERCEDES TRUCK 1630 1990/99 1632 1999/02 1625 1989/96 2225 1987/90 2325 1989/00

MERCEDES BUS O 371 R 1992/97 O 371 UP 1990/97 O 400 R 1994/97 O 400 UP 1995/97 ; O 400 UPA 1995/98 OH 1625/OH 1630 1990/95 ; OH 1628 1998/04

MERCEDES OM 447A/447LA 6 CIL 12V 12L TURBO

MERCEDES TRUCK 1634 2001/05 1934 1984/91 2635 1992/99 1941 1989/97 1935 1989/99 2638/2038 1996/98

MERCEDES BUS O 371 RS/O 371 RSD 1990/98 O400 RSL/RSD 1994/99 O400 RS 1994/03 O 400 RSE/O 371 RSE 1997/99 OH 1625/OH 1636 1994/95

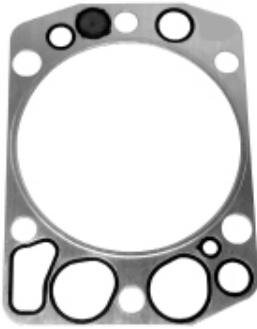

56137200



56130490



56132298

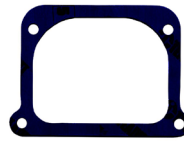

56130290



56141317

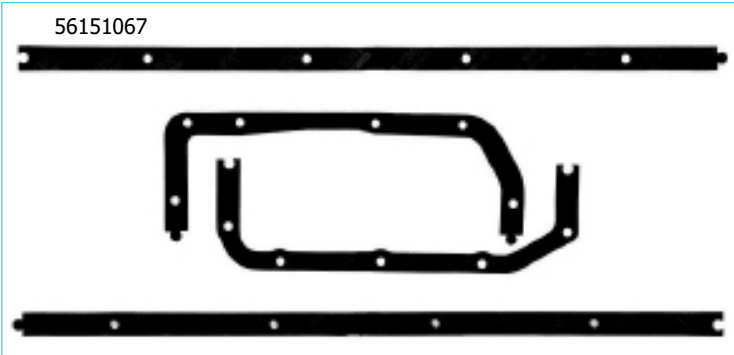

56151067

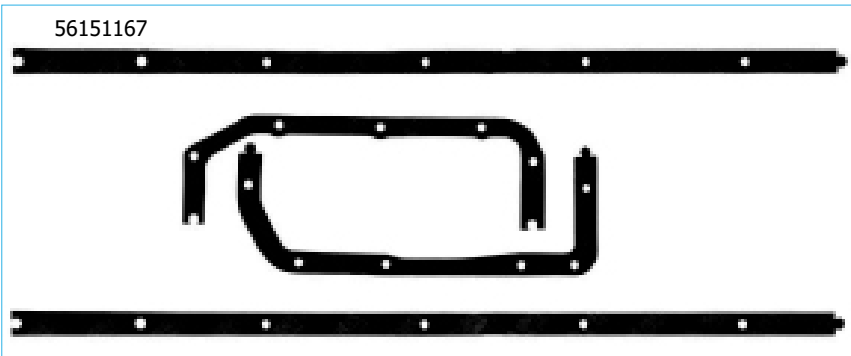

56151167



56129890

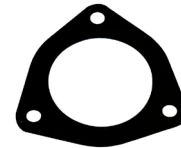

56130616



56139239



56142490

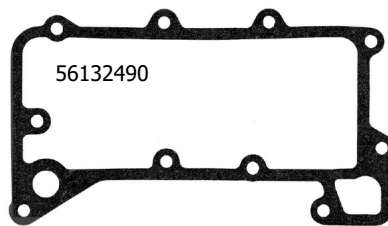

56132490



54308395



56132795



56132950



56128690

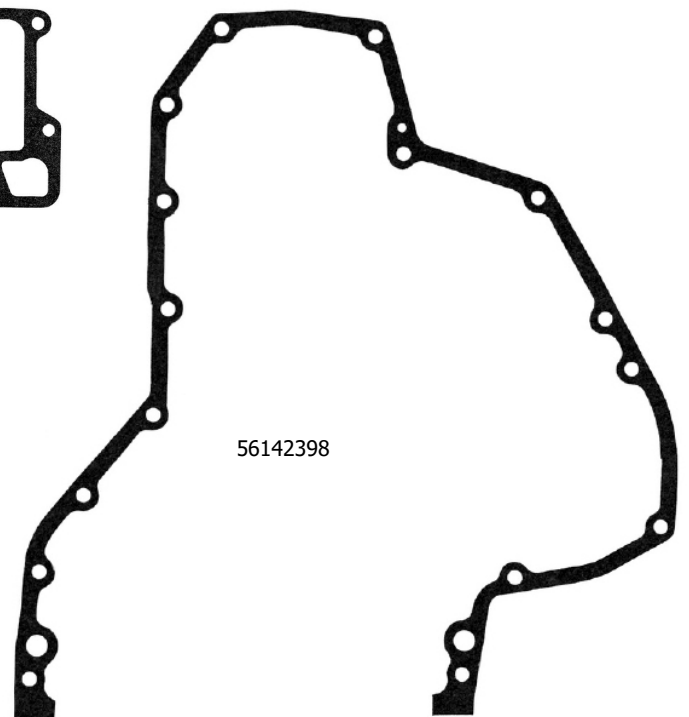

56142398

MERCEDES BENZ

MERCEDES BENZ OM 457 ELETRÔNICO /2004

N°SET	DESCRIPTION			
66114619	FULL GASKET SET MERCEDES OM 457 ATÉ MOTOR 085588 /2004 C/ANÉL CAMISA W/O OIL SEAL			1
76114619	FULL GASKET SET MERCEDES OM 457 ATÉ MOTOR 085588 /2004 C/ANÉL CAMISA W/OIL SEAL			2
66134619	HEAD GASKET SET P/1 Cab CYLINDER Até Motor 085588 /04 C/Anel Camisa W/O OIL SEAL			3
76134619	HEAD GASKET SET P/1 Cab CYLINDER Até Motor 085588 /04 C/Anel Camisa W/OIL SEAL			4
ABR N°	ORIGINAL N°	DESCRIPTION		
50011023	7,3X15,0MM	WASHER SET	1	1
RE02697T	0139971447	REAR OIL SEAL		1
RE02696T	0149974617	FRONT OIL SEAL		1
56130390	4222011480	WATER PUMP GASKET		1 1
56139239	4031420380	EXHAUST MANIFOLD GASKET	1 1	6 6
56141119	4570110259	LINER SHIM	1 1	6 6
56142377	4290150080	FRONT COVER GASKET		1 1
56142490	9170030260	OIL COOLER GASKET		2 2
56151167	4070140222	OIL PAN GASKET		1 1
56165940	4570160021	VALVE COVER GASKETS	1 1	6 6
56164590	4572010080	WATER PUMP GASKET		1 1
56164967	4570160021	VALVE COVER GASKET	1	1
56132298	4030110080	FRONT COVER GASKET		1 1
56132490	4031840280	OIL FILTER GASKET		1 1
56165367	4602010080	JT CONEX		1 1
56165431	4570810180	FUEL PUMP GASKET		1 1
56165567	6171870180	INLET OIL GASKET		1 1
56165667	4421870080	TURBOCHARING GASKET		1 1
56165716	4571410080	INTAKE MANIFOLD GASKET	1 1	6 6
56166040	4579970545	LINER RING	2	2
56169405	4570161120	CYLINDER HEAD GASKET	1 1	6 6
86151140		RUBBER KITACHA		1 1
86151329		WASHER KITUELA		1 1
RE09237F	0000535258	VALVE STEM SEAL	4	24

APPLICATION

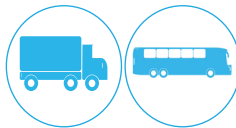

MERCEDES OM 457LA 6 CIL 12L 24 ATÉ MOTOR 32558(CYLINDER S/REBAIXO)EURO 3

MERCEDES TRUCK AXOR 1938/2638 1998/06 1944 2002/05

MERCEDES BUS O400 RSD 1998/04 O 400 RSE 1998/02

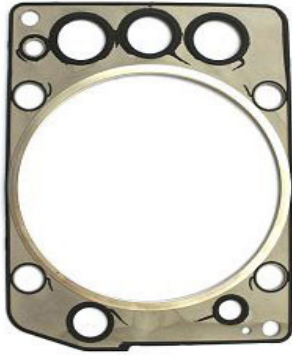

56169405

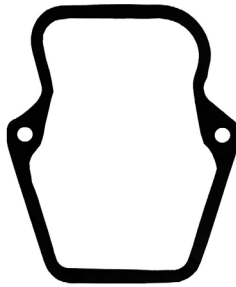

56164967

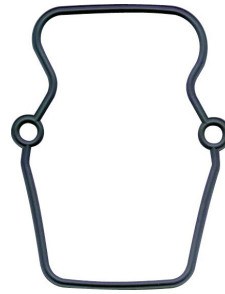

56165940



50011023



RE09237F



56132298



56139239

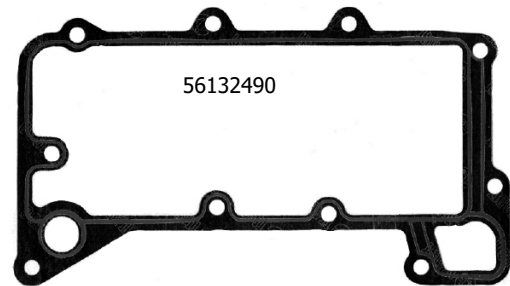

56132490



56165367

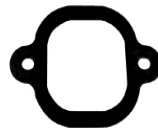

56165716



56165431

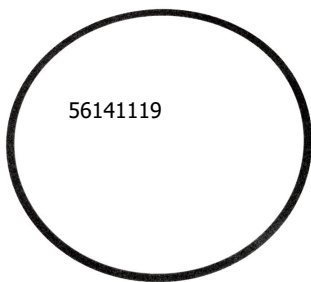

56141119



56166040

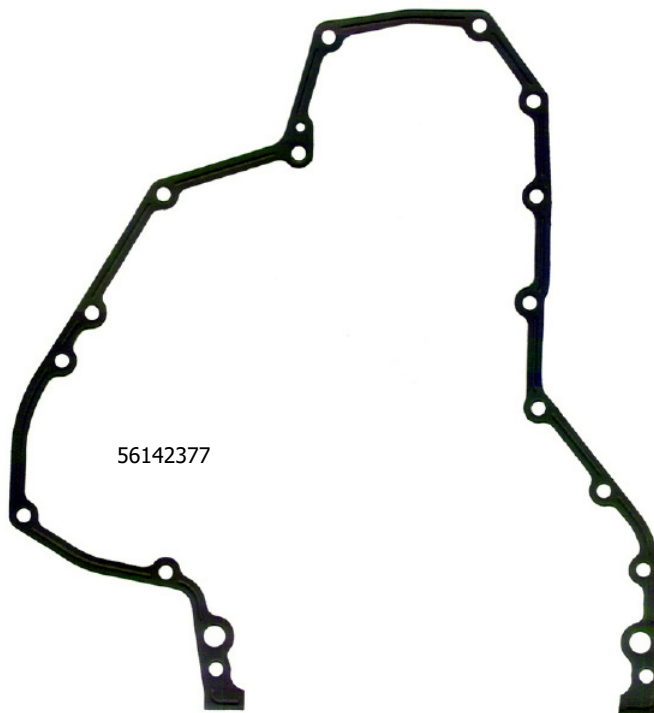

56142377



56164590



56130390

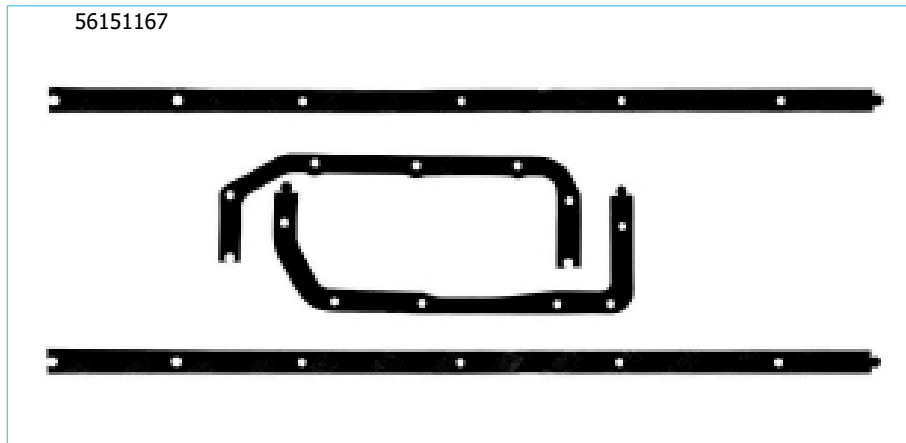

56165667



56142490



56165567



RE02696T



RE02697T

86151140 RUBBER KITaCHA OM 457		
Nº ABR	DESCRIPTION	Qty
56116040	Anel Camisa 144,5x159,1x7,0mm	12
50037341	Vedador 15,0 x 2,5 mm	01
50011741	vedador 57,0 x 3,5 mm	01
54388340	vedador 82,15 x 3,5 mm	01
	vedador 79,85 x 3,0 mm	02

86151329 WASHER KITUELAS OM 457		
Nº ABR	DESCRIPTION	Qty
50023624	WASHER SET CU 16,3 x 19,8 x 1,5	02
50072424	mm	01
50030420	WASHER SET CU 22,5 x 26,7 x 1,5	01
	mm	01
50022224	WASHER SET CU 26,0 x 32,0 x 2,0	03
50022229	mm	01
50029720	WASHER SET CU 26,3 x 31,7 x 3,0	02
50011023	mm	06

NºSET	DESCRIPTION		
66114631	FULL GASKET SET MERCEDES OM 457 MOTOR 085589 2004/ EURO 3 E 5 W/O OIL SEAL		1
76114631	FULL GASKET SET MERCEDES OM 457 MOTOR 085589 2004/ EURO 3 E 5 W/		2
66134631	HEAD GASKET SET P/1 CAB 085589 04/ EURO 3 E 5 W/O OIL SEAL		3
ABR Nº	ORIGINAL Nº	DESCRIPTION	
50011023	7,3X15 MM	WASHER SET	6 6
RE05184T		FRONT OIL SEAL	1
RE05155T		REAR OIL SEAL	1
56130390	4222010480	WATER PUMP GASKET	1 1
56139239	4031420380	EXHAUST MANIFOLD GASKET	6 6
56141119	4570110259	LINER SHIM	6 6
56142377	4290150080	FRONT COVER GASKET	1 1
56142490	9170030260	OIL COOLER GASKET	2 2
56165940	4570160221	VALVE COVER GASKETS	1 6 6
56160530	4570980180	INTAKE MANIFOLD GASKET	1 6 6
56164590	4572010080	WATER PUMP GASKET	1 1
56164967	4570160021	VALVE COVER GASKET	6 6
56165005	4570161220	CYLINDER HEAD GASKET	1 6 6
56165167	5410110080	FRONT COVER GASKET	1 1
56180067	4571880280	OIL RADIADOR GASKET	1 1
56165431	4570810180	FUEL PUMP GASKET	1 1
56165567	6171870180	INLET OIL GASKET	1 1
56165667	4421870080	TURBOCHARING GASKET	1 1
56165716	4571410080	INTAKE MANIFOLD GASKET	6 6
56166040	4579970545	LINER RING GASKET	
56168030	5411420380	INTAKE MANIFOLD GASKET	1 6 6
56169767	4570140122	OIL PAN GASKET	1 1
86151140		RUBBER KITACHA	1 1
86151329		WASHER KITUELA	1 1
RE09237F		AFTER COOLER GASKET	24
56174231		VEDADOR TMP VALVULA	2 12 12
56178867	4570980880	INTAKE MANIFOLD GASKET	1 1
56178967		BREATHER GASKET	1 1
56178767	4570110880	FRONT COVER GASKET	1 1
56179067	4600110180	COVER OIL SEAL GASKET	1 1
56180850	A4570150080	PIPE BREATHER GASKET	1 1

APPLICATION

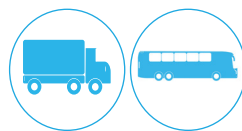

MERCEDES OM 457LA 6 CIL 12L 24 APÓS MOTOR 32559(CYLINDER C/REBAIXO)EURO 3 E 5
 MERCEDES TRUCK AXOR 1634/2640/4144 2006/12 ; 2035/2040/2044/2544/2644/3344 2005/12 ; 2535 2009/13 ; 2036 2011/
 2041/2541 2011/...2536 2012/...2540 2004/12 ; 3340 2005/11 ; 4140 2005/11 ; 2641/3341/4141 2012/16 ; 2544/2644 2013/ 3344/4144 2013/...ATRON 1635 2012/...
 3344/4144 2013/...ATRON 1635 2012/...
 MERCEDES BUS O 500 MA/O 500 UA/O 500 RS/O 500 RSD 2006/12 ; O 500 RSDD/UDA/MDA 2013/...

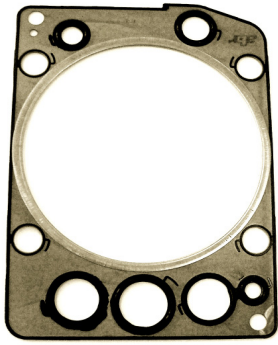

56165005

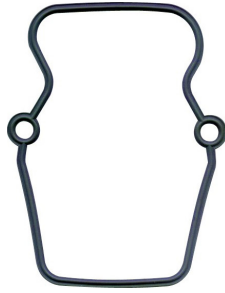

56165940

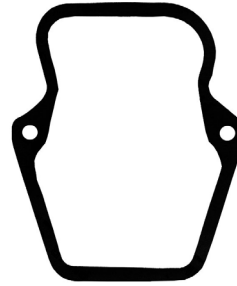

56164967



RE09237F

56174231

50011023



56160530



56165716



56168030



56139239



56132298

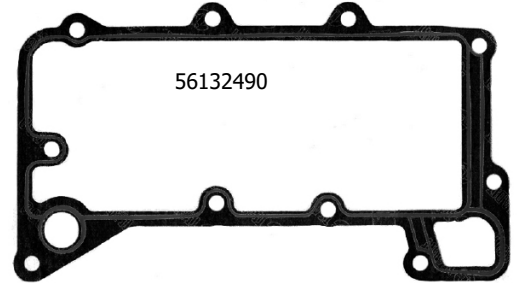

56132490

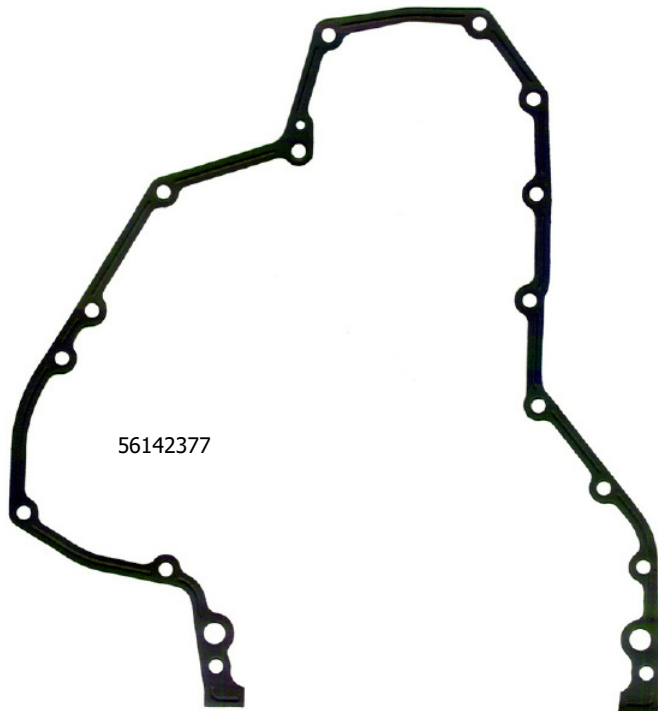

56142377

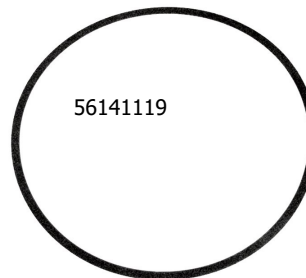

56141119



56165367



56130390



56166040



56164590



56178867



56178967

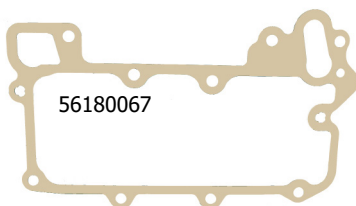

56180067

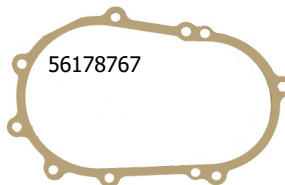

56178767



56179067

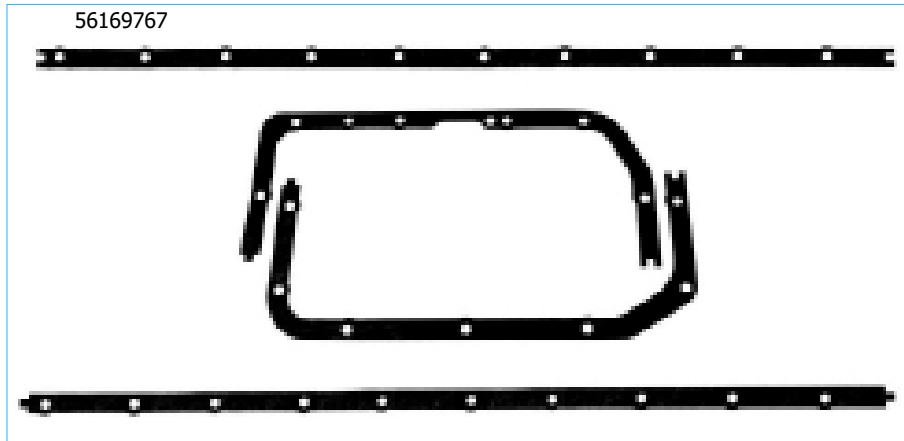

56165431



56142490



56165567



56165667



RE05184T



RE05155T



56180850

86151140		
Nº ABR	DESCRIPTION	Qty
56116040	Anel Camisa 144,5x159,1x7,0mm	12
50037341	Vedador 15,0 x 2,5 mm	01
50011741	vedador 57,0 x 3,5 mm	01
54388340	vedador 82,15 x 3,5 mm	01
	vedador 79,85 x 3,0 mm	02

86151329		
Nº ABR	DESCRIPTION	Qty
50023624	WASHER SET CU 16,3 x 19,8 x 1,5	02
50072424	mm	01
50030420	WASHER SET CU 22,5 x 26,7 x 1,5	01
	mm	01
50022224	WASHER SET CU 26,0 x 32,0 x 2,0	03
50022229	mm	01
50029720	WASHER SET cu 26,3 x 31,7 x 3,0	02
50011023	mm	06

MERCEDES BENZ

MERCEDES BENZ OM 611 ELETRÔNICO

N°SET	DESCRIPTION		
76114651	FULL GASKET SET MERCEDES OM 611 SPRINTER 413 CDI 2.2 16V 98/ W/OIL SEAL		1
76134651	HEAD GASKET SET MERCEDES OM 611 SPRINTER 413 CDI 2.2 16V 98/ W/OIL SEAL		2
ABR N°	ORIGINAL N°	DESCRIPTION	
RE07927F		VALVE STEM SEAL	16 16
56175040	6110160121	VALVE COVER GASKET	1 1
56175131	6420140022	OIL PAN GASKET	1
56175231	6111420780	INTAKE MANIFOLD GASKET	1 1
56175302	6110161120	CYLINDER HEAD GASKET	1 1
56174930	6112010280	WATER PUMP GASKET	1
56175440	6110980380	INTAKE MANIFOLD GASKET	4 4
86152426		WASHER KIT	1 1
86152526		RUBBER KIT	1
RE05813S	611010214	REAR OIL SEAL	1
RE07795T	0219977647	FRONT OIL SEAL	1
50011923		WASHER SET	4
56176540	6112030380	WATER PUMP GASKET	1 1

APPLICATION



MERCEDES VITO VAN 108/110/112 CDI 1998/V200/220CDI 1999/ SPRINTER VAN 208/211/213/308/311/313/316/408/411/413/416 CDI 1999/...
 SPRINTER VAN 208/211/213/308/311/313/316/408/411/413/416 CDI 1999/...

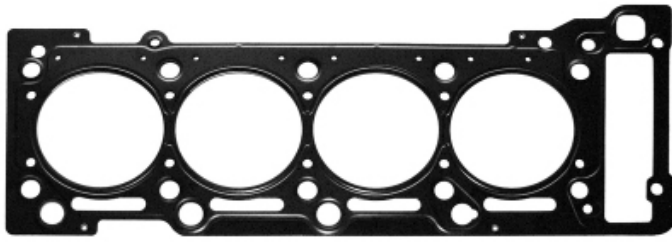

56175302

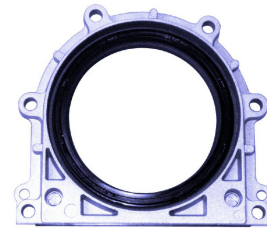

RE05813S

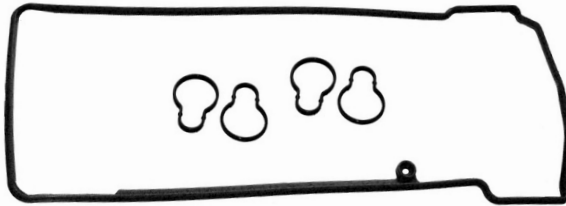

56175040



RE7795T

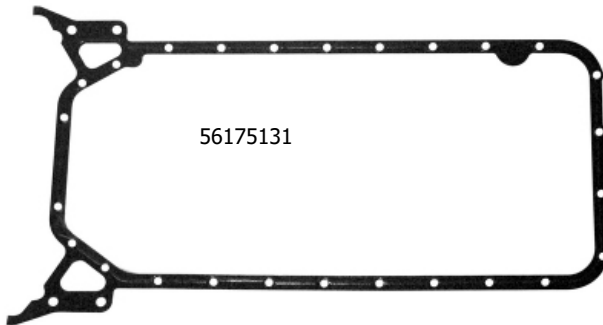

56175131



56174930



56175231



56175440

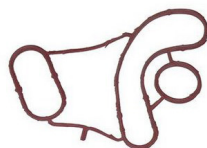

56176540



RE07927F

86152426		
Nº ABR	DESCRIPTION	Qty
50030425	WASHER SET AL 26,0 x 32,0 x 2,0 mm	01
50021524	WASHER SET CU 14,3 x 19,8 x 1,5 mm	01
50021123	WASHER SET AL 14,0 x 18,0 x 1,5 mm	01
50011023	WASHER SET CU 7,2 x 15,2 x 1,5 mm	04

86152546		
Nº Original	DESCRIPTION	Qty
0189971948	Vedador 26,5 x 2,1 mm	01
1110180080	Vedador 47,5 x 59,0 x 2,3 mm	01
0069977548	Vedador 36,5 x 2,0 mm	01
0069977648	Vedador 12,0 x 2,0 mm	01
1049970048	Vedador 10,0 x 2,0 mm	01
0229978048	Vedador 8,6 x 2,5 mm	01
6112030380	Vedador Bomba d' Água	01
6111840280	Vedador Filtro Óleo	01
6110980380	Vedador Coletor Admissão	04

N°SET	DESCRIPTION							
66119041	FULL GASKET SET MERCEDES OM 904 4 CILS W/O OIL SEAL							1
76119041	FULL GASKET SET MERCEDES OM 904 4 CILS W/OIL SEAL							2
66139041	HEAD GASKET SET 904 4 CILS W/O OIL SEAL							3
76139041	HEAD GASKET SET 904 4 CILS VALVE STEM SEAL W/OIL SEAL							4
66119241	FULL GASKET SET MERCEDES OM 924 4 CILS W/O OIL SEAL							5
76119241	FULL GASKET SET MERCEDES OM 924 4 CILS W/OIL SEAL							6
66139241	HEAD GASKET SET OM 924 4 CILS W/O OIL SEAL							7
76139241	HEAD GASKET SET OM 924 4 CILS VALVE STEM SEAL W/OIL SEAL							8

ABR N°	ORIGINAL N°	DESCRIPTION						
RE05155T	0219975347	REAR OIL SEAL			1			1
RE05214T	0229977647	FRONT OIL SEAL			1			1
56172905	9040161120	CYLINDER HEAD GASKET					1	1
56173105	9240160720	CYLINDER HEAD GASKET	1	1	1	1		1
56173340	0000160421	VALVE COVER GASKET	1	1	1	1	1	1
56173540	9040160721	SIDE VALVE COVER GASKET	1	1	1	1	1	1
56173831	9062030180	WATER CIRCULATION GASKET	1	1	1	1	1	1
56174367	9062010080	WATER PUMP GASKET			1	1		1
56174431	9061410180	INTAKE MANIFOLD GASKET	2	2	2	2	2	2
56174667	9040140622	OIL PAN GASKET			1	1		1
56174867	9041880280	OIL RADIATOR GASKET			1	1		1
56174931	9060910380	FUEL PUMP GASKET	1	1	1	1	1	1
56175030	9061420280	EXHAUST MANIFOLD GASKET	2	2	2	2	2	2
86151626		WASHER KITUELA			1	1	1	1
86152046		RUBBER KITACHA			1	1	1	1
RE09284F	9060530358	AFTER COOLER GASKET	12	12	12	12		
56179140	9041410280	INTAKE MANIFOLD GASKET	4	4	4	4		
56174231	0000160040	VEDADOR TMP VALVULA	5	5	5	5	5	5
56175640	9061840280	OIL FILTER GASKET					5	5
56175840	0001883280	OIL COOLER GASKET				1	1	1

APLICAÇÃO

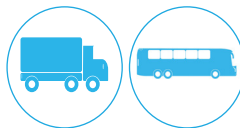

MERCEDES OM 904 4 CIL 4.25L ELETRÔNICO(EURO 3 E 5)

MERCEDES TRUCK 1215C 1999/04 ; 914C 1999/03 ; 1718 2000/12 ; 1318 2003/12 ; 1218 2001/04 ; 1418 2001/03

MERCEDES BUS ATILIS 712E 2006/09 LO 914 1999/04 LO 915 2003/12 OF 1218 2007/11 OF 1417 2001/06 OF 1418 2003/11 OH 1417 1998/05

ATEGO 1418 2004/12 ; ATEGO 1315 2005/10 ; ATEGO 1518/1718 2005/12 ; ACCELO 915C 2002/12

MERCEDES BUS ATILIS 712E 2006/09 ; LO 914 1999/04 ; LO 915 2003/12 ; OF 1218 2007/11 ; OF 1417 2001/06 ; OF 1418 2003/11

OH 1417 1998/05 ; OH 1418 2003/07 ; OH 1518 2006/12 ; OH 1519 2013/...

MERCEDES OM 924 4 CIL 4.8L ELETRÔNICO(EURO 3 E 5)TURBO

MERCEDES TRUCK 1622 2001/05 ; ACCELO 815/1016 2011/...ACCELO 1316 2015/...ATEGO 1419 2012/...ATEGO 1719 2011/ ATRON 1319 2012/16 ; ATRON 1719 2013/16

MERCEDES BUS OH 1521 1999/02 OH 1622L 2007/12 OF 1722 2001/11 OF 1722M 2003/12 OF 1721/OF 1721L 2004/

OH 1621L 2013/...VOLARE BUS W9 FLY/DW9 FLY 2012/14

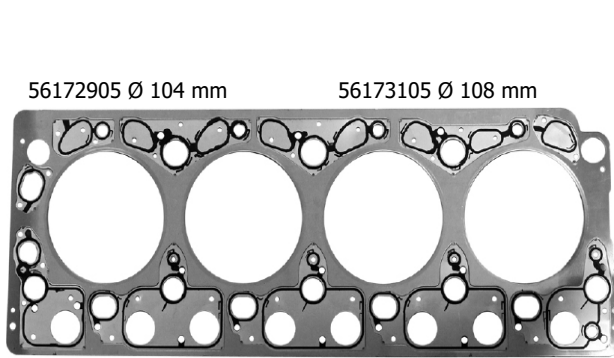

56175030



56174431



56179140



56173831



76175840



56174931



56174231



56173540



56173340

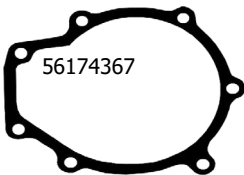

56174367



56174867

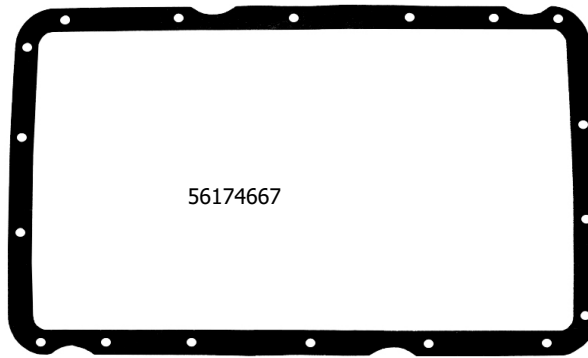

56174667



76175640



RE09284F



RE05214T



RE05155T

86151626			86152046		
Nº ABR	DESCRIPTION	Qtd	Nº Original	DESCRIPTION	Qtd
50030420	WASHER SET CU 26,0 x 32,0 x 2,0	01	0279978348	Vedador 37,8 x 2,62 mm	08
50027329	mm	02	0239976848	Vedador 9,0 x 2,5 mm	04
50069229	WASHER SET CU 20,0 x 26,0 x 1,5	01	5419970745	Vedador 25,0 x 3,7 mm	04
50025424	mm	01	5419970545	Vedador 20,9 x 3,0 mm	04
50021524	WASHER SET AL 18,0 x 22,0 x 1,5	01	5419970645	Vedador 11,0 x 3,0 mm	04
50021229	mm	01	0209971148	Vedador 60,0 x 4,2 mm	02
50011023	WASHER SET AL 18,0 x 24,0 x 1,5	04	0249972148	Vedador 118,0 x 3,0 mm	01
			0020941580	Vedador	01
			9061840280	Vedador Filtro Óleo	01

N°SET	DESCRIPTION							
66119061	FULL GASKET SET MERCEDES OM 906 6 CILS W/O OIL SEAL							1
76119061	FULL GASKET SET MERCEDES OM 906 6 CILS W/OIL SEAL/ENTOR							2
66139061	HEAD GASKET SET 906 6 CILS W/O OIL SEAL							3
76139061	HEAD GASKET SET 906 6 CILS VALVE STEM SEAL W/OIL SEAL							4
66119261	FULL GASKET SET MERCEDES OM 926 6 CILS W/O OIL SEAL							5
76119261	FULL GASKET SET MERCEDES OM 926 6 CILS W/OIL SEAL							6
66139261	HEAD GASKET SET OM 926 6 CILS W/O OIL SEAL							7
76139261	HEAD GASKET SET OM 926 6 CILS VALVE STEM SEAL W/OIL SEAL							8

ABR N°	ORIGINAL N°	DESCRIPTION						
RE05155T	0219975347	REAR OIL SEAL					1	1
RE05214T	0229977647	FRONT OIL SEAL					1	1
56173005	9060161220	CYLINDER HEAD GASKET					1	1
56173205	9260160820	CYLINDER HEAD GASKET	1	1	1	1	1	1
56173440	0000160521	VALVE COVER GASKET	1	1	1	1	1	1
56173640	9060160721	SIDE COVER GASKET	1	1	1	1	1	1
56173831	9062030180	WATER CIRCULATION GASKET	1	1	1	1	1	1
56174367	9022010080	WATER PUMP GASKET					1	1
56174431	9061410180	INTAKE MANIFOLD GASKET	3	3	3	3	3	3
56174567	9061880280	OIL RADIATOR GASKET					1	1
56174767		OIL PAN GASKET					1	1
56174931	9060910380	FUEL PUMP GASKET	1	1	1	1	1	1
56175030	9061420280	EXHAUST MANIFOLD GASKET	3	3	3	3	3	3
86151826		WASHER KITUELAS					1	1
86152146		RUBBER KITACHA					1	1
RE09284F	9060530358	VALVE STEM SEAL	18	18	18	18	18	18
56179140	9041410280	INTAKE MANIFOLD GASKET	6	6	6	6	6	6
56174231	0000160040	VALVE COVER GASKET	7	7	7	7	7	7
56175640	9061840280	OIL FILTER GASKET					1	1
56175740	0001883280	OIL COOLER GASKET					1	1

APPLICATION



MERCEDES OM 906 6 CIL 6.4L ELETRÔNICO(EURO 3 E 5)

MERCEDES TRUCK 2423 1999/09 ; 2726 2008/12 ; 1620 2006/12 ; ATEGO 1725 2009/12 ; ATEGO 2425 2005/12

AXOR 2826 2006/11 ; MERCEDES BUS O 500 U 2013/...OH 1635 1995/99

MERCEDES OM 926 6 CIL 7.2L ELETRÔNICO(EURO 3 E 5)TURBO

MERCEDES TRUCK 1728 2003/06 ; 2428 2001/06 ; ATEGO 1726/1729 2013/... ATEGO 1728/2428 2007/12 ; ATEGO 2426 2011/...

ATEGO 2429 2012/15 ; ATEGO 2430 2014/...ATEGO 1730/2730/3026/3030 2016/...ATRON 2324/2729 2011/16 ;

AXOR 1933/2533 2005/...AXOR 2831 2012/15 ; AXOR 3131 2013/...

MERCEDES BUS O 500 M 2001/2011 ; O 500 R 2005/11 ; OF 1730 2010/12

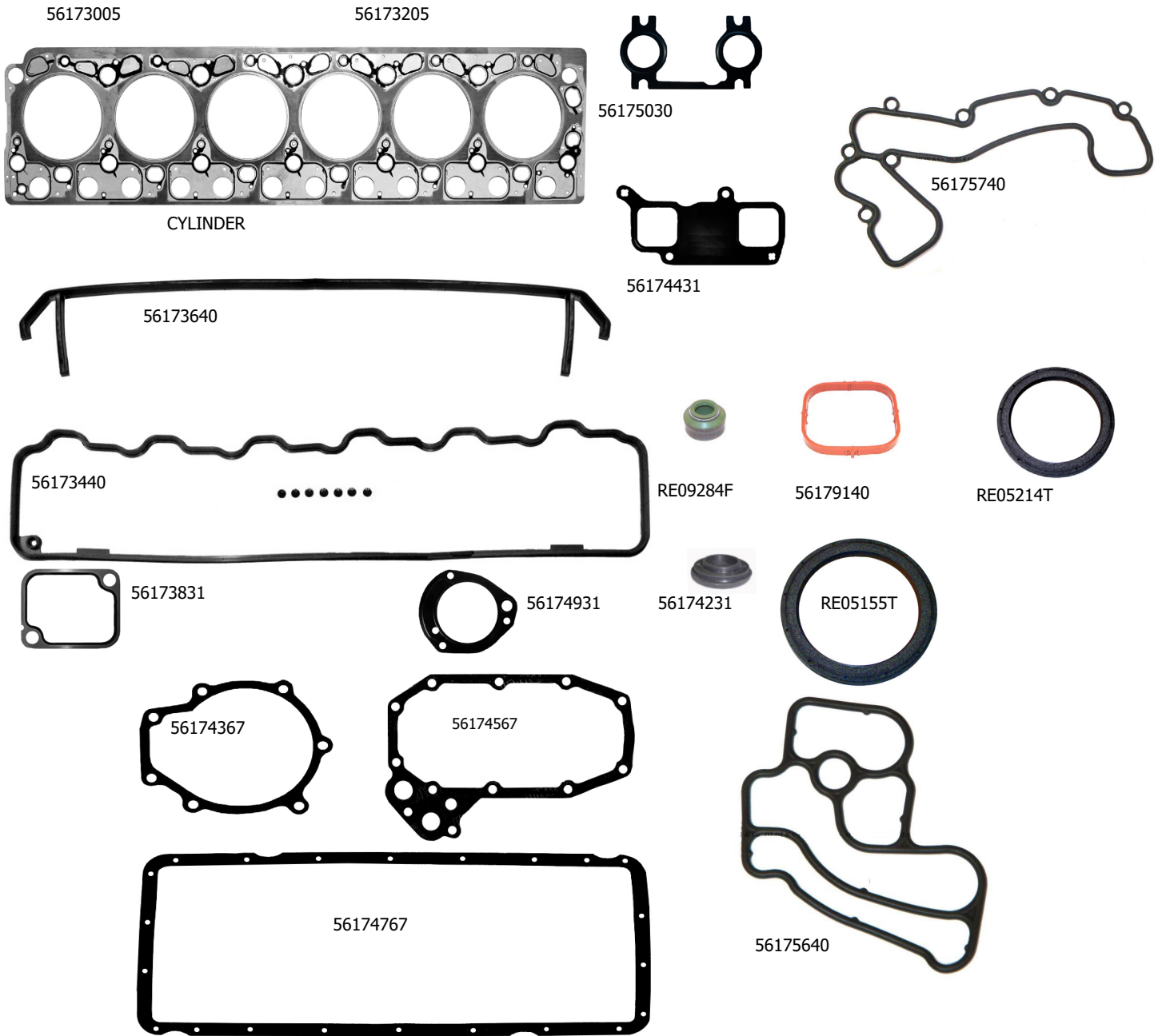

86151826			86152146		
Nº ABR	DESCRIPTION	Qty	Nº Original	DESCRIPTION	Qty
50030420	WASHER SET CU 26,0 x 32,0 x 2,0	01	0279978348	Vedador 37,8 x 2,62 mm	08
50027329	mm	02	0239976848	Vedador 9,0 x 2,5 mm	06
50069229	WASHER SET CU 20,0 x 26,0 x 1,5	01	5419970745	Vedador 25,0 x 3,7 mm	06
50021524	mm	01	5419970545	Vedador 20,9 x 3,0 mm	06
50023624	WASHER SET AL 18,0 x 22,0 x 1,5	01	5419970645	Vedador 11,0 x 3,0 mm	06
50021229	mm	01	0209971148	Vedador 60,0 x 4,2 mm	02
50011023	WASHER SET CU 14,3 x 19,8 x 1,5	06	0249972148	Vedador 118,0 x 3,0 mm	01
			0020941580	Vedador	01
			9061840280	Vedador Filtro Óleo	01

MERCEDES BENZ

MERCEDES BENZ OM612 ACCELO 715C 2.7

N°SET	DESCRIPTION			
76114682	FULL GASKET SET MERCEDES OM612 ACCELO 715C 2.7 INCLUSIVE FLANGE TRASEIRO MLS W/OIL SEAL			1
76134682	HEAD GASKET SET MERCEDES OM612 ACCELO 715C 2.7 INCLUSIVE FLANGE TRASEIRO MLS W/OIL SEAL			2
ABR N°	ORIGINAL N°	DESCRIP-		
56176002	6470161420	CYLINDER HEAD GASKET	1	1
56176140	6120160021	VALVE COVER GASKET	1	1
56176230	6121410180	INTAKE MANIFOLD GASKET	1	1
56176330	6121450380	EXHAUST GASKET	1	1
56176430	6120140122	OIL PAN GASKET		1
RE05813S	6110100214	REAR OIL SEAL		1
RE07795T	0219977647	FRONT OIL SEAL		1
RE07927F	0000534158	VALVE STEM SEAL	20	20
56176630		OIL COOLER GASKET		1
56176830		INLET OIL GASKET		1
56176540	6111840280	OIL FILTER GASKET		1
56176730	6112010280	WATER PUMP GASKET		1
86152640		RUBBER KITACHA	1	1
56177040	6110940080	INTAKE MANIFOLD GASKET	5	5
56177140		OIL COOLER GASKET		1

APPLICATION



MERCEDES OM 612 5 CIL 2.7L 20V ELETRÔNICO(EURO 3)

MERCEDES TRUCK ACCELO 715C DI 2002/11 ; JEEP GRAN CHEROKEE II 2001/05

MERCEDES BENZ OM612 ACCELO 715C 2.7

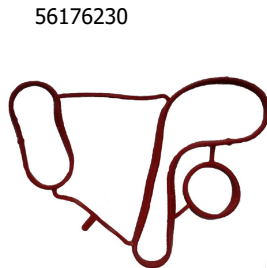
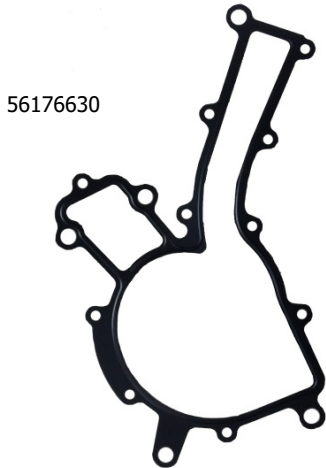
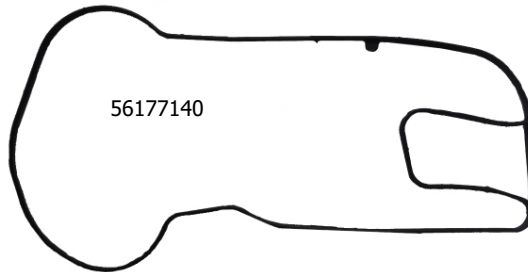
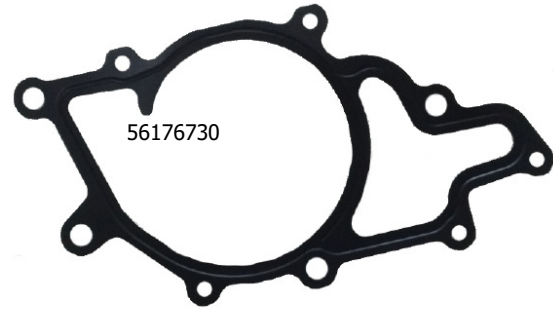
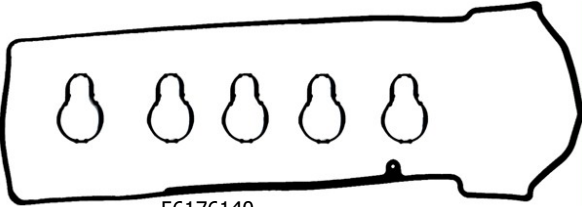
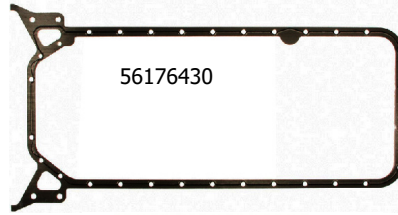

86152640



MERCEDES BENZ

OM651 SPRINTER 311/415/515 CDI 2.1 16V 2012

N°SET	DESCRIPTION		
76112702	FULL GASKET SET MERCEDES OM651 SPRINTER 311/415/515 CDI 2.1 16V 2012/ W/OIL SEAL		1
76132702	HEAD GASKET SETMERCEDES OM651 SPRINTER 311/415/515 CDI 2.1 16V 2012/ W/OIL SEAL		2
ABR N°	ORIGINAL N°	DESCRIPTION	
56177302	6510160220	CYLINDER HEAD GASKET	1 1
56177240	6510160321	VOLVE COVER GASKET	1 1
56177540	6510140080	OIL PAN GASKET	1
56177640	6510910060	INTAKE MANIFOLD GASKET	1 1
56177432	6511420580	EXHAUST GASKET	1 1
RE09115F	60*75*75/85	FRONT OIL SEAL	1
RE09116F	96*114*9	REAR OIL SEAL	1
RE09203F	5*85*95	VALVE STEM SEAL	16 16
56177730		EXHASUT PIPE GASKET	1 1
56177830	6510961180	REAR COVER GASKET	1 1
56177918	6511422680	EGR VALVE GASKET	1 1
56178030	6510960480	TURBO GASKET	1 1
56178130	6511420380	EGR VALVE GASKET	1 1
56178230	6511420480	EGR VALVE GASKET	1 1
56178330	6511421280	EGR VALVE GASKET	1 1
56178430	6511421380	EGR VALVE GASKET	1 1
56178530	6511422380	EGR VALVE GASKET	1 1
56178630	6510960280	OIL RETURNE GASKET	1 1
56178730	6512380180	OIL PUMP GASKET	1 1
56178830	6511422480	OIL COOLER GASKET	1 1
86152740		RUBBER KIT	1
86152840		TOP RUBBER KIT	1

APPLICATION



MERCEDES OM 651 4 CIL 2.2L 16V ELETRÔNICO(EURO 5)

MERCEDES VANS SPRINTER 311/415/515 CDI 2012/...

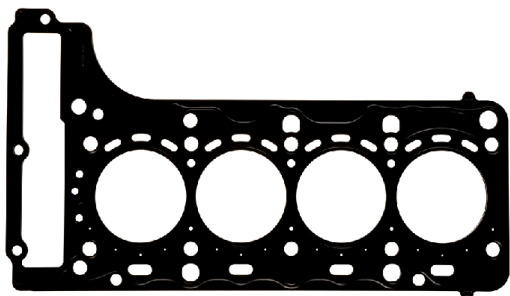

56177302

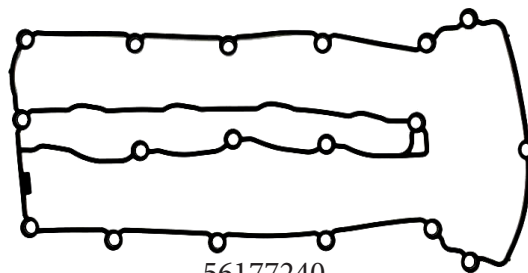

56177240

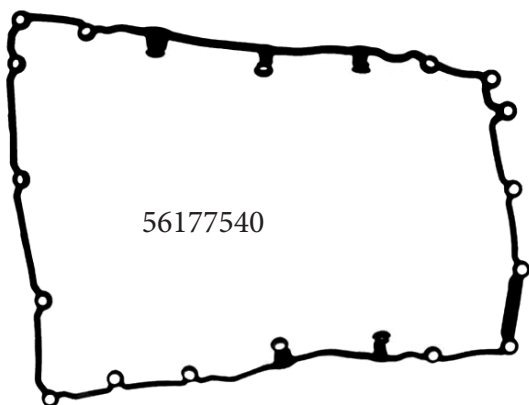

56177540



56177640



RE09115F



56177432

